

ESP32-WROOM-32

Datasheet

NOT RECOMMENDED
FOR NEW DESIGNS
(NRND)



Version 3.4
Espressif Systems
Copyright © 2023

About This Document

This document provides the specifications for the ESP32-WROOM-32 module.

Document Updates

Please always refer to the latest version on <https://www.espressif.com/en/support/download/documents>.

Revision History

For revision history of this document, please refer to the [last page](#).

Documentation Change Notification

Espressif provides email notifications to keep customers updated on changes to technical documentation.

Please subscribe at www.espressif.com/en/subscribe. Note that you need to update your subscription to receive notifications of new products you are not currently subscribed to.

Certification

Download certificates for Espressif products from www.espressif.com/en/certificates.

Contents

1	Overview	6
2	Pin Definitions	8
2.1	Pin Layout	8
2.2	Pin Description	8
2.3	Strapping Pins	10
3	Functional Description	12
3.1	CPU and Internal Memory	12
3.2	External Flash and SRAM	12
3.3	Crystal Oscillators	12
3.4	RTC and Low-Power Management	13
4	Peripherals and Sensors	14
5	Electrical Characteristics	15
5.1	Absolute Maximum Ratings	15
5.2	Recommended Operating Conditions	15
5.3	DC Characteristics (3.3 V, 25 °C)	15
5.4	Wi-Fi Radio	16
5.5	Bluetooth LE Radio	17
5.5.1	Receiver	17
5.5.2	Transmitter	17
6	Schematics	18
7	Peripheral Schematics	19
8	Physical Dimensions	20
9	Recommended PCB Land Pattern	21
10	Product Handling	22
10.1	Storage Conditions	22
10.2	Electrostatic Discharge (ESD)	22
10.3	Reflow Profile	22
10.4	Ultrasonic Vibration	23
11	Related Documentation and Resources	24
	Revision History	25

List of Tables

1	ESP32-WROOM-32 Specifications	6
2	Pin Definitions	8
3	Strapping Pins	10
4	Parameter Descriptions of Setup and Hold Times for the Strapping Pins	11
5	Absolute Maximum Ratings	15
6	Recommended Operating Conditions	15
7	DC Characteristics (3.3 V, 25 °C)	15
8	Wi-Fi Radio Characteristics	16
9	Receiver Characteristics – Bluetooth LE	17
10	Transmitter Characteristics – Bluetooth LE	17

List of Figures

1	ESP32-WROOM-32 Pin Layout (Top View)	8
2	Setup and Hold Times for the Strapping Pins	11
3	ESP32-WROOM-32 Schematics	18
4	ESP32-WROOM-32 Peripheral Schematics	19
5	Physical Dimensions of ESP32-WROOM-32	20
6	Recommended PCB Land Pattern	21
7	Reflow Profile	22

1 Overview

ESP32-WROOM-32 is a powerful, generic Wi-Fi + Bluetooth® + Bluetooth LE MCU module that targets a wide variety of applications, ranging from low-power sensor networks to the most demanding tasks, such as voice encoding, music streaming and MP3 decoding.

At the core of this module is the ESP32-D0WDQ6 chip*. The chip embedded is designed to be scalable and adaptive. There are two CPU cores that can be individually controlled, and the CPU clock frequency is adjustable from 80 MHz to 240 MHz. The chip also has a low-power coprocessor that can be used instead of the CPU to save power while performing tasks that do not require much computing power, such as monitoring of peripherals. ESP32 integrates a rich set of peripherals, ranging from capacitive touch sensors, SD card interface, Ethernet, high-speed SPI, UART, I2S, and I2C.

Note:

* For details on the part numbers of the ESP32 family of chips, please refer to the document [ESP32 Datasheet](#).

The integration of Bluetooth, Bluetooth LE and Wi-Fi ensures that a wide range of applications can be targeted, and that the module is all-around: using Wi-Fi allows a large physical range and direct connection to the Internet through a Wi-Fi router, while using Bluetooth allows the user to conveniently connect to the phone or broadcast low energy beacons for its detection. The sleep current of the ESP32 chip is less than 5 μ A, making it suitable for battery powered and wearable electronics applications. The module supports a data rate of up to 150 Mbps, and 20 dBm output power at the antenna to ensure the widest physical range. As such the module does offer industry-leading specifications and the best performance for electronic integration, range, power consumption, and connectivity.

The operating system chosen for ESP32 is freeRTOS with LwIP; TLS 1.2 with hardware acceleration is built in as well. Secure (encrypted) over the air (OTA) upgrade is also supported, so that users can upgrade their products even after their release, at minimum cost and effort.

Table 1 provides the specifications of ESP32-WROOM-32.

Table 1: ESP32-WROOM-32 Specifications

Categories	Items	Specifications
Certification	RF certification	See certificates for ESP32-WROOM-32
	Wi-Fi certification	Wi-Fi Alliance
	Bluetooth certification	BQB
	Green certification	RoHS/REACH
Test	Reliability	HTOL/HTSL/uHAST/TCT/ESD
Wi-Fi	Protocols	802.11 b/g/n (802.11n up to 150 Mbps)
		A-MPDU and A-MSDU aggregation and 0.4 μ s guard interval support
	Center frequency range of operating channel	2412 ~ 2484 MHz
Bluetooth	Protocols	Bluetooth v4.2 BR/EDR and Bluetooth LE specification
	Radio	NZIF receiver with -97 dBm sensitivity
		Class-1, class-2 and class-3 transmitter
		AFH

[Not Recommended For New Designs \(NRND\)](#)

Categories	Items	Specifications
	Audio	CVSD and SBC
Hardware	Module interfaces	SD card, UART, SPI, SDIO, I2C, LED PWM, Motor PWM, I2S, IR, pulse counter, GPIO, capacitive touch sensor, ADC, DAC, Two-Wire Automotive Interface (TWAI [®]), compatible with ISO11898-1 (CAN Specification 2.0)
	Integrated crystal	40 MHz crystal
	Integrated SPI flash	4 MB
	Operating voltage/Power supply	3.0 V ~ 3.6 V
	Operating current	Average: 80 mA
	Minimum current delivered by power supply	500 mA
	Recommended operating ambient temperature range	-40 °C ~ +85 °C
	Package size	18 mm × 25.5 mm × 3.10 mm
	Moisture sensitivity level (MSL)	Level 3

2 Pin Definitions

2.1 Pin Layout

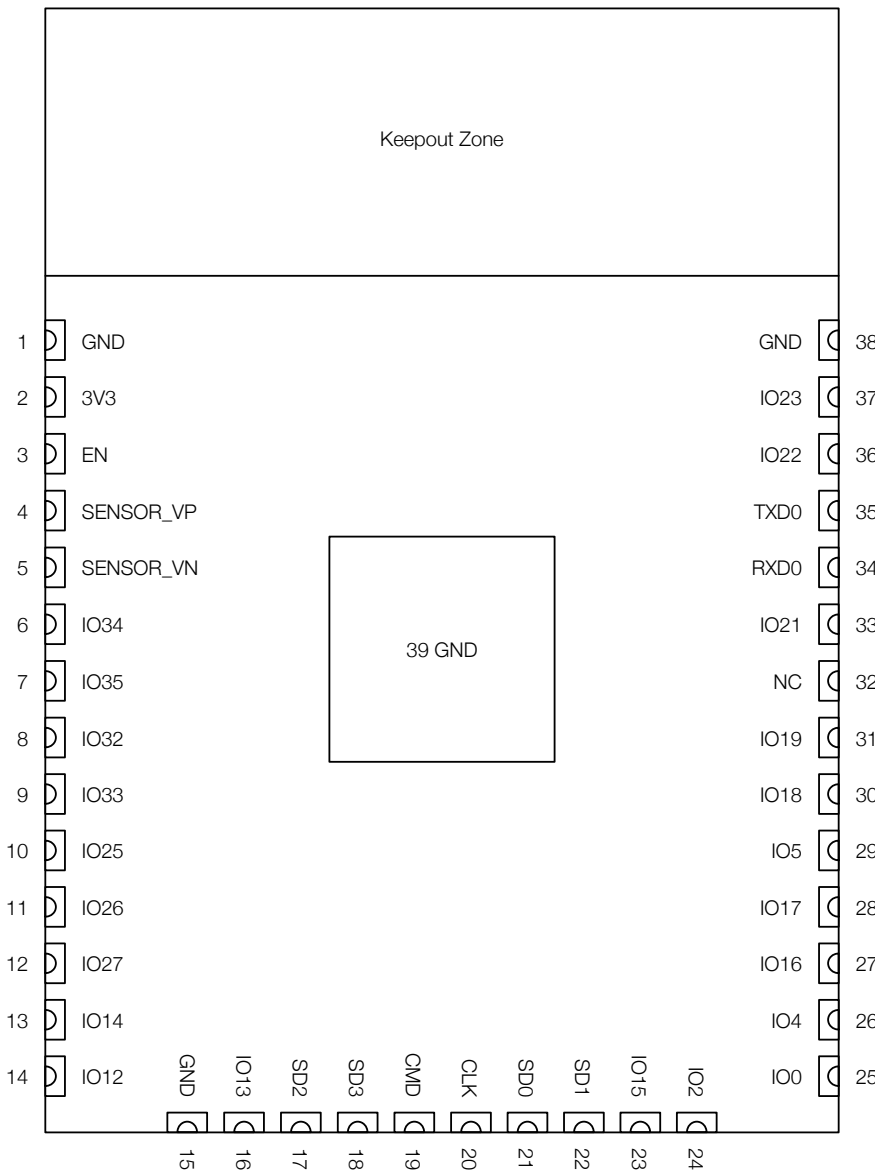

Figure 1: ESP32-WROOM-32 Pin Layout (Top View)

2.2 Pin Description

ESP32-WROOM-32 has 38 pins. See pin definitions in Table 2.

Table 2: Pin Definitions

Name	No.	Type	Function
GND	1	P	Ground
3V3	2	P	Power supply
EN	3	I	Module-enable signal. Active high.

[Not Recommended For New Designs \(NRND\)](#)

Name	No.	Type	Function
SENSOR_VP	4	I	GPIO36, ADC1_CH0, RTC_GPIO0
SENSOR_VN	5	I	GPIO39, ADC1_CH3, RTC_GPIO3
IO34	6	I	GPIO34, ADC1_CH6, RTC_GPIO4
IO35	7	I	GPIO35, ADC1_CH7, RTC_GPIO5
IO32	8	I/O	GPIO32, XTAL_32K_P (32.768 kHz crystal oscillator input), ADC1_CH4, TOUCH9, RTC_GPIO9
IO33	9	I/O	GPIO33, XTAL_32K_N (32.768 kHz crystal oscillator output), ADC1_CH5, TOUCH8, RTC_GPIO8
IO25	10	I/O	GPIO25, DAC_1, ADC2_CH8, RTC_GPIO6, EMAC_RXD0
IO26	11	I/O	GPIO26, DAC_2, ADC2_CH9, RTC_GPIO7, EMAC_RXD1
IO27	12	I/O	GPIO27, ADC2_CH7, TOUCH7, RTC_GPIO17, EMAC_RX_DV
IO14	13	I/O	GPIO14, ADC2_CH6, TOUCH6, RTC_GPIO16, MTMS, HSPICLK, HS2_CLK, SD_CLK, EMAC_TXD2
IO12	14	I/O	GPIO12, ADC2_CH5, TOUCH5, RTC_GPIO15, MTDI, HSPIQ, HS2_DATA2, SD_DATA2, EMAC_TXD3
GND	15	P	Ground
IO13	16	I/O	GPIO13, ADC2_CH4, TOUCH4, RTC_GPIO14, MTCK, HSPID, HS2_DATA3, SD_DATA3, EMAC_RX_ER
SHD/SD2*	17	I/O	GPIO9, SD_DATA2, SPIHD, HS1_DATA2, U1RXD
SWP/SD3*	18	I/O	GPIO10, SD_DATA3, SPIWP, HS1_DATA3, U1TXD
SCS/CMD*	19	I/O	GPIO11, SD_CMD, SPICS0, HS1_CMD, U1RTS
SCK/CLK*	20	I/O	GPIO6, SD_CLK, SPICLK, HS1_CLK, U1CTS
SDO/SD0*	21	I/O	GPIO7, SD_DATA0, SPIQ, HS1_DATA0, U2RTS
SDI/SD1*	22	I/O	GPIO8, SD_DATA1, SPID, HS1_DATA1, U2CTS
IO15	23	I/O	GPIO15, ADC2_CH3, TOUCH3, MTDO, HSPICS0, RTC_GPIO13, HS2_CMD, SD_CMD, EMAC_RXD3
IO2	24	I/O	GPIO2, ADC2_CH2, TOUCH2, RTC_GPIO12, HSPIWP, HS2_DATA0, SD_DATA0
IO0	25	I/O	GPIO0, ADC2_CH1, TOUCH1, RTC_GPIO11, CLK_OUT1, EMAC_TX_CLK
IO4	26	I/O	GPIO4, ADC2_CH0, TOUCH0, RTC_GPIO10, HSPIHD, HS2_DATA1, SD_DATA1, EMAC_TX_ER
IO16	27	I/O	GPIO16, HS1_DATA4, U2RXD, EMAC_CLK_OUT
IO17	28	I/O	GPIO17, HS1_DATA5, U2TXD, EMAC_CLK_OUT_180
IO5	29	I/O	GPIO5, VSPICS0, HS1_DATA6, EMAC_RX_CLK
IO18	30	I/O	GPIO18, VSPICLK, HS1_DATA7
IO19	31	I/O	GPIO19, VSPIQ, U0CTS, EMAC_TXD0
NC	32	-	-
IO21	33	I/O	GPIO21, VSPIHD, EMAC_TX_EN
RXD0	34	I/O	GPIO3, U0RXD, CLK_OUT2
TXD0	35	I/O	GPIO1, U0TXD, CLK_OUT3, EMAC_RXD2
IO22	36	I/O	GPIO22, VSPiWP, U0RTS, EMAC_TXD1
IO23	37	I/O	GPIO23, VSPID, HS1_STROBE
GND	38	P	Ground

Notice:

* Pins SCK/CLK, SDO/SD0, SDI/SD1, SHD/SD2, SWP/SD3 and SCS/CMD, namely, GPIO6 to GPIO11 are connected to the integrated SPI flash integrated on the module and are not recommended for other uses.

2.3 Strapping Pins

ESP32 has five strapping pins, which can be seen in Chapter 6 Schematics:

- MTDI
- GPIO0
- GPIO2
- MTDO
- GPIO5

Software can read the values of these five bits from register “GPIO_STRAPPING”.

During the chip’s system reset release (power-on-reset, RTC watchdog reset and brownout reset), the latches of the strapping pins sample the voltage level as strapping bits of “0” or “1”, and hold these bits until the chip is powered down or shut down. The strapping bits configure the device’s boot mode, the operating voltage of VDD_SDIO and other initial system settings.

Each strapping pin is connected to its internal pull-up/pull-down during the chip reset. Consequently, if a strapping pin is unconnected or the connected external circuit is high-impedance, the internal weak pull-up/pull-down will determine the default input level of the strapping pins.

To change the strapping bit values, users can apply the external pull-down/pull-up resistances, or use the host MCU’s GPIOs to control the voltage level of these pins when powering on ESP32.

After reset release, the strapping pins work as normal-function pins.

Refer to Table 3 for a detailed boot-mode configuration by strapping pins.

Table 3: Strapping Pins

Voltage of Internal LDO (VDD_SDIO)					
Pin	Default	3.3 V		1.8 V	
MTDI	Pull-down	0		1	
Bootling Mode					
Pin	Default	SPI Boot		Download Boot	
GPIO0	Pull-up	1		0	
GPIO2	Pull-down	Don't-care		0	
Enabling/Disabling Debugging Log Print over U0TXD During Bootling					
Pin	Default	U0TXD Active		U0TXD Silent	
MTDO	Pull-up	1		0	
Timing of SDIO Slave					
Pin	Default	FE Sampling FE Output	FE Sampling RE Output	RE Sampling FE Output	RE Sampling RE Output
MTDO	Pull-up	0	0	1	1
GPIO5	Pull-up	0	1	0	1

Note:

- Firmware can configure register bits to change the settings of "Voltage of Internal LDO (VDD_SDIO)" and "Timing of SDIO Slave" after booting.
- The module integrates a 3.3 V SPI flash, so the pin MTDI cannot be set to 1 when the module is powered up.

The illustration below shows the setup and hold times for the strapping pins before and after the CHIP_PU signal goes high. Details about the parameters are listed in Table 4.

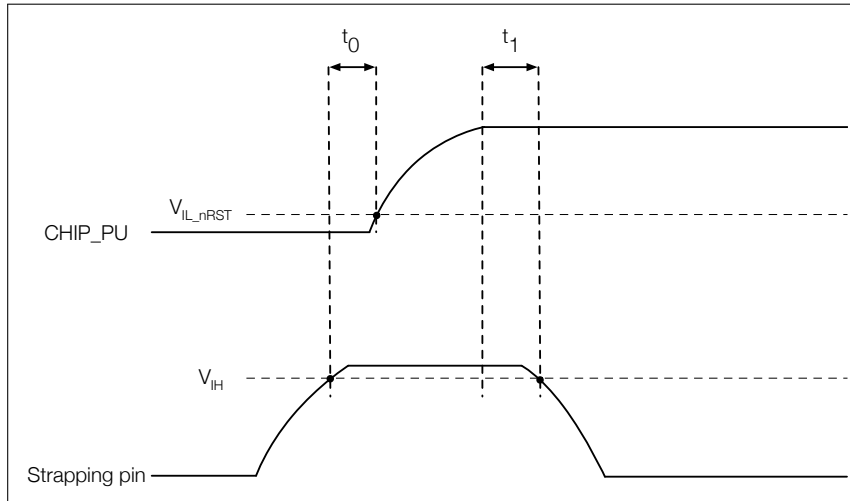

Figure 2: Setup and Hold Times for the Strapping Pins

Table 4: Parameter Descriptions of Setup and Hold Times for the Strapping Pins

Parameters	Description	Min.	Unit
t_0	Setup time before CHIP_PU goes from low to high	0	ms
t_1	Hold time after CHIP_PU goes high	1	ms

3 Functional Description

This chapter describes the modules and functions integrated in ESP32-WROOM-32.

3.1 CPU and Internal Memory

ESP32-D0WDQ6 contains two low-power Xtensa® 32-bit LX6 microprocessors. The internal memory includes:

- 448 KB of ROM for booting and core functions.
- 520 KB of on-chip SRAM for data and instructions.
- 8 KB of SRAM in RTC, which is called RTC FAST Memory and can be used for data storage; it is accessed by the main CPU during RTC Boot from the Deep-sleep mode.
- 8 KB of SRAM in RTC, which is called RTC SLOW Memory and can be accessed by the co-processor during the Deep-sleep mode.
- 1 Kbit of eFuse: 256 bits are used for the system (MAC address and chip configuration) and the remaining 768 bits are reserved for customer applications, including flash-encryption and chip-ID.

3.2 External Flash and SRAM

ESP32 supports multiple external QSPI flash and SRAM chips. More details can be found in Chapter SPI in the [ESP32 Technical Reference Manual](#). ESP32 also supports hardware encryption/decryption based on AES to protect developers' programs and data in flash.

ESP32 can access the external QSPI flash and SRAM through high-speed caches.

- The external flash can be mapped into CPU instruction memory space and read-only memory space simultaneously.
 - When external flash is mapped into CPU instruction memory space, up to 11 MB + 248 KB can be mapped at a time. Note that if more than 3 MB + 248 KB are mapped, cache performance will be reduced due to speculative reads by the CPU.
 - When external flash is mapped into read-only data memory space, up to 4 MB can be mapped at a time. 8-bit, 16-bit and 32-bit reads are supported.
- External SRAM can be mapped into CPU data memory space. Up to 4 MB can be mapped at a time. 8-bit, 16-bit and 32-bit reads and writes are supported.

ESP32-WROOM-32 integrates a 4 MB SPI flash, which is connected to GPIO6, GPIO7, GPIO8, GPIO9, GPIO10 and GPIO11. These six pins cannot be used as regular GPIOs.

3.3 Crystal Oscillators

The module uses a 40-MHz crystal oscillator.

3.4 RTC and Low-Power Management

With the use of advanced power-management technologies, ESP32 can switch between different power modes.

For details on ESP32's power consumption in different power modes, please refer to section "RTC and Low-Power Management" in [ESP32 Datasheet](#).

4 Peripherals and Sensors

Please refer to Section Peripherals and Sensors in [ESP32 Datasheet](#).

Note:

External connections can be made to any GPIO except for GPIOs in the range 6-11. These six GPIOs are connected to the module's integrated SPI flash. For details, please see Section 6 Schematics.

5 Electrical Characteristics

5.1 Absolute Maximum Ratings

Stresses beyond the absolute maximum ratings listed in Table 5 below may cause permanent damage to the device. These are stress ratings only, and do not refer to the functional operation of the device that should follow the [recommended operating conditions](#).

Table 5: Absolute Maximum Ratings

Symbol	Parameter	Min	Max	Unit
VDD33	Power supply voltage	-0.3	3.6	V
I_{output}^1	Cumulative IO output current	-	1,100	mA
T_{store}	Storage temperature	-40	105	°C

1. The module worked properly after a 24-hour test in ambient temperature at 25 °C, and the IOs in three domains (VDD3P3_RTC, VDD3P3_CPU, VDD_SDIO) output high logic level to ground. Please note that pins occupied by flash and/or PSRAM in the VDD_SDIO power domain were excluded from the test.
2. Please see Appendix IO_MUX of [ESP32 Datasheet](#) for IO's power domain.

5.2 Recommended Operating Conditions

Table 6: Recommended Operating Conditions

Symbol	Parameter	Min	Typical	Max	Unit
VDD33	Power supply voltage	3.0	3.3	3.6	V
I_{VDD}	Current delivered by external power supply	0.5	-	-	A
T	Operating ambient temperature	-40	-	85	°C

5.3 DC Characteristics (3.3 V, 25 °C)

Table 7: DC Characteristics (3.3 V, 25 °C)

Symbol	Parameter		Min	Typ	Max	Unit
C_{IN}	Pin capacitance		-	2	-	pF
V_{IH}	High-level input voltage		$0.75 \times VDD^1$	-	$VDD^1 + 0.3$	V
V_{IL}	Low-level input voltage		-0.3	-	$0.25 \times VDD^1$	V
I_{IH}	High-level input current		-	-	50	nA
I_{IL}	Low-level input current		-	-	50	nA
V_{OH}	High-level output voltage		$0.8 \times VDD^1$	-	-	V
V_{OL}	Low-level output voltage		-	-	$0.1 \times VDD^1$	V
I_{OH}	High-level source current ($VDD^1 = 3.3$ V, $V_{OH} \geq 2.64$ V, output drive strength set to the maximum)	VDD3P3_CPU power domain ^{1, 2}	-	40	-	mA
		VDD3P3_RTC power domain ^{1, 2}	-	40	-	mA
		VDD_SDIO power domain ^{1, 3}	-	20	-	mA

[Not Recommended For New Designs \(NRND\)](#)

Symbol	Parameter	Min	Typ	Max	Unit
I_{OL}	Low-level sink current ($V_{DD}^1 = 3.3\text{ V}$, $V_{OL} = 0.495\text{ V}$, output drive strength set to the maximum)	-	28	-	mA
R_{PU}	Resistance of internal pull-up resistor	-	45	-	$k\Omega$
R_{PD}	Resistance of internal pull-down resistor	-	45	-	$k\Omega$
V_{IL_nRST}	Low-level input voltage of CHIP_PU to shut down the chip	-	-	0.6	V

Notes:

1. Please see Appendix IO_MUX of [ESP32 Datasheet](#) for IO's power domain. VDD is the I/O voltage for a particular power domain of pins.
2. For VDD3P3_CPU and VDD3P3_RTC power domain, per-pin current sourced in the same domain is gradually reduced from around 40 mA to around 29 mA, $V_{OH} \geq 2.64\text{ V}$, as the number of current-source pins increases.
3. Pins occupied by flash and/or PSRAM in the VDD_SDIO power domain were excluded from the test.

5.4 Wi-Fi Radio

Table 8: Wi-Fi Radio Characteristics

Parameter	Condition	Min	Typical	Max	Unit
Center frequency range of operating channel <i>note1</i>	-	2412	-	2484	MHz
Output impedance <i>note2</i>	-	-	<i>note 2</i>	-	Ω
TX power <i>note3</i>	11n, MCS7	12	13	14	dBm
	11b mode	17.5	18.5	20	dBm
Sensitivity	11b, 1 Mbps	-	-98	-	dBm
	11b, 11 Mbps	-	-89	-	dBm
	11g, 6 Mbps	-	-92	-	dBm
	11g, 54 Mbps	-	-74	-	dBm
	11n, HT20, MCS0	-	-91	-	dBm
	11n, HT20, MCS7	-	-71	-	dBm
	11n, HT40, MCS0	-	-89	-	dBm
	11n, HT40, MCS7	-	-69	-	dBm
Adjacent channel rejection	11g, 6 Mbps	-	31	-	dB
	11g, 54 Mbps	-	14	-	dB
	11n, HT20, MCS0	-	31	-	dB
	11n, HT20, MCS7	-	13	-	dB

1. Device should operate in the center frequency range of operating channel allocated by regional regulatory authorities. Target center frequency range of operating channel is configurable by software.
2. For the modules that use external antennas, the output impedance is 50 Ω . For other modules without external antennas, users do not need to concern about the output impedance.
3. Target TX power is configurable based on device or certification requirements.

5.5 Bluetooth LE Radio

5.5.1 Receiver

Table 9: Receiver Characteristics – Bluetooth LE

Parameter	Conditions	Min	Typ	Max	Unit
Sensitivity @30.8% PER	-	-	-97	-	dBm
Maximum received signal @30.8% PER	-	0	-	-	dBm
Co-channel C/I	-	-	+10	-	dB
Adjacent channel selectivity C/I	F = F0 + 1 MHz	-	-5	-	dB
	F = F0 - 1 MHz	-	-5	-	dB
	F = F0 + 2 MHz	-	-25	-	dB
	F = F0 - 2 MHz	-	-35	-	dB
	F = F0 + 3 MHz	-	-25	-	dB
	F = F0 - 3 MHz	-	-45	-	dB
Out-of-band blocking performance	30 MHz ~ 2000 MHz	-10	-	-	dBm
	2000 MHz ~ 2400 MHz	-27	-	-	dBm
	2500 MHz ~ 3000 MHz	-27	-	-	dBm
	3000 MHz ~ 12.5 GHz	-10	-	-	dBm
Intermodulation	-	-36	-	-	dBm

5.5.2 Transmitter

Table 10: Transmitter Characteristics – Bluetooth LE

Parameter	Conditions	Min	Typ	Max	Unit
RF transmit power	-	-	0	-	dBm
Gain control step	-	-	3	-	dBm
RF power control range	-	-12	-	+9	dBm
Adjacent channel transmit power	F = F0 ± 2 MHz	-	-52	-	dBm
	F = F0 ± 3 MHz	-	-58	-	dBm
	F = F0 ± > 3 MHz	-	-60	-	dBm
Δf_{1avg}	-	-	-	265	kHz
Δf_{2max}	-	247	-	-	kHz
$\Delta f_{2avg}/\Delta f_{1avg}$	-	-	-0.92	-	-
ICFT	-	-	-10	-	kHz
Drift rate	-	-	0.7	-	kHz/50 μ s
Drift	-	-	2	-	kHz

6 Schematics

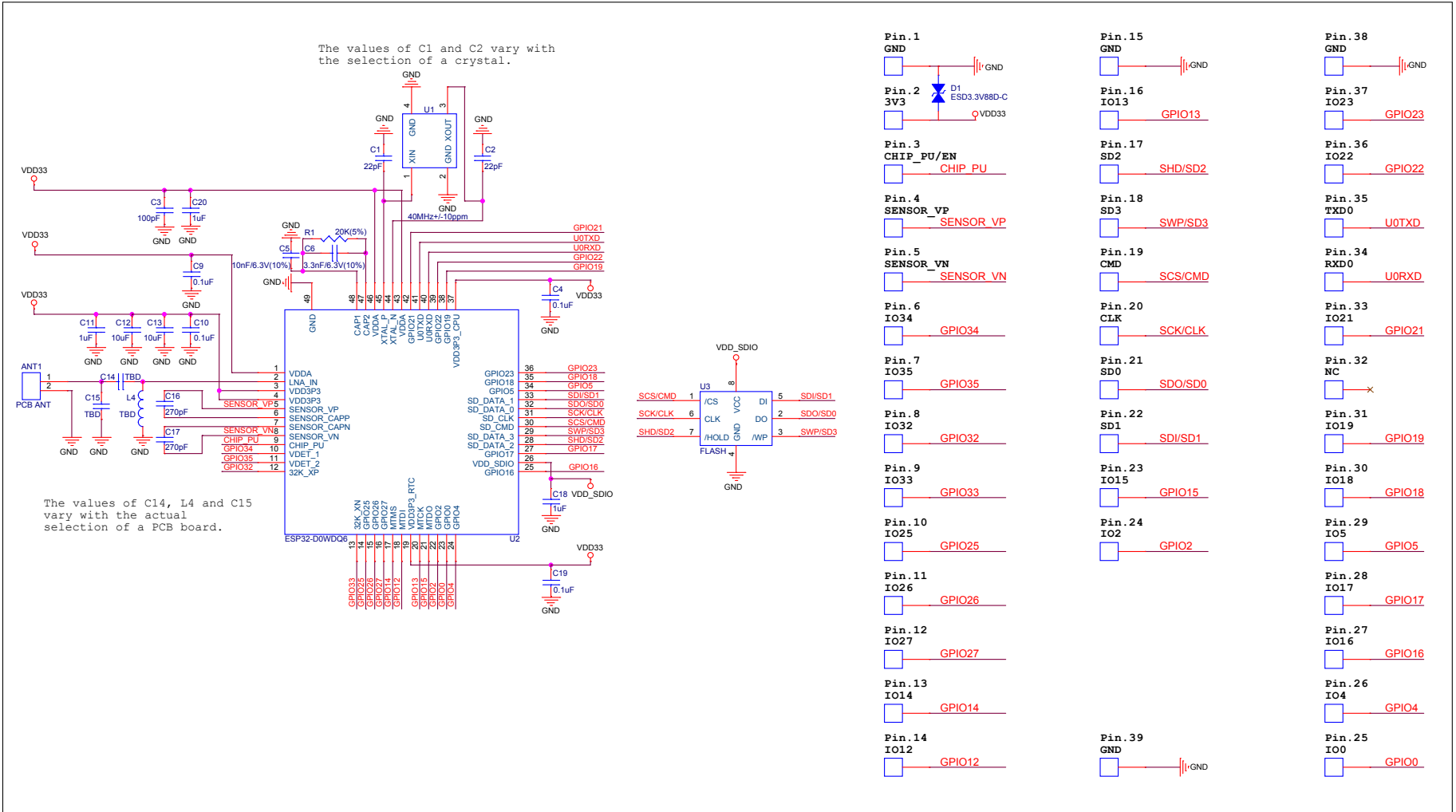

Figure 3: ESP32-WROOM-32 Schematics

7 Peripheral Schematics

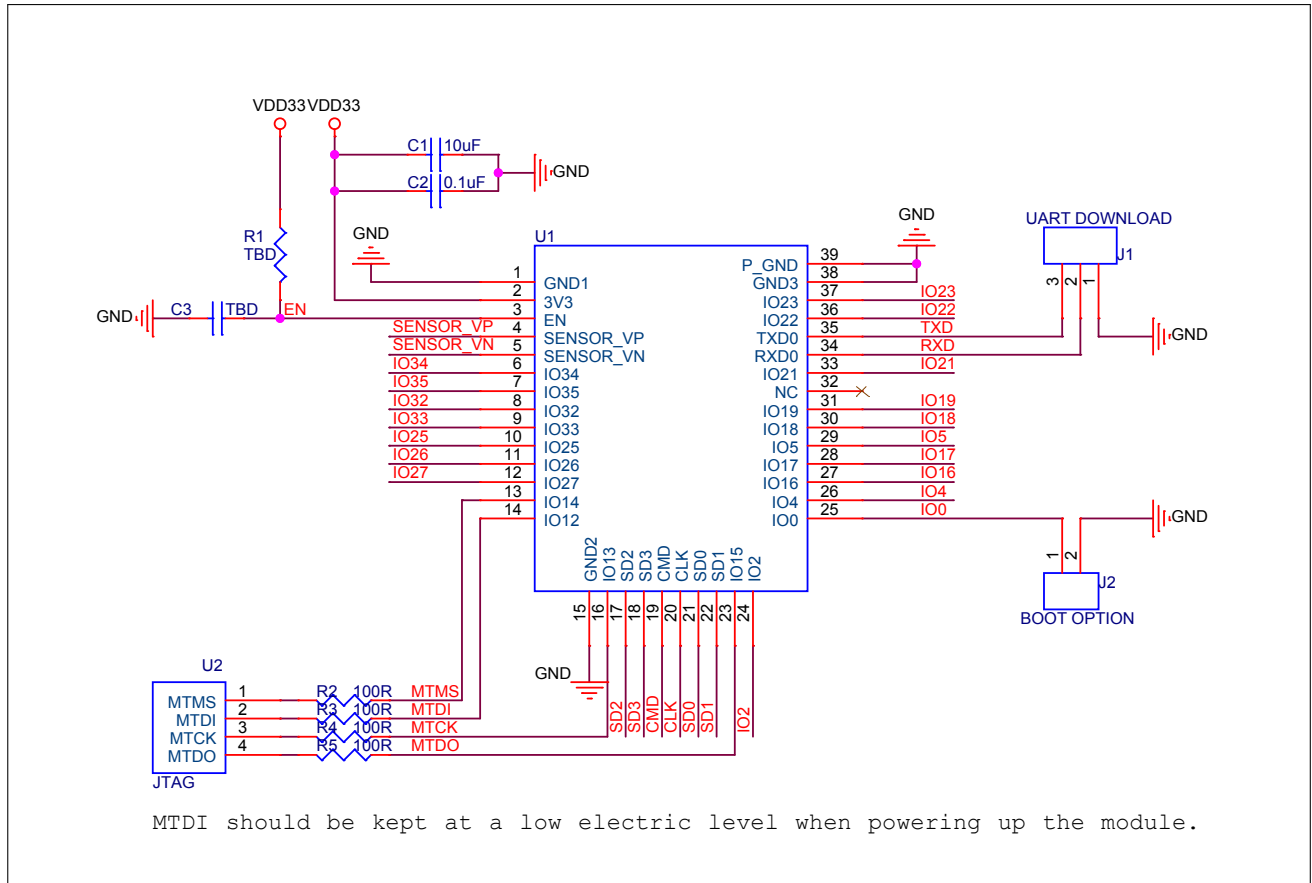

Figure 4: ESP32-WROOM-32 Peripheral Schematics

Note:

- Soldering Pad 39 to the Ground of the base board is not necessary for a satisfactory thermal performance. If users do want to solder it, they need to ensure that the correct quantity of soldering paste is applied.
- To ensure the power supply to the ESP32 chip during power-up, it is advised to add an RC delay circuit at the EN pin. The recommended setting for the RC delay circuit is usually $R = 10\text{ k}\Omega$ and $C = 1\ \mu\text{F}$. However, specific parameters should be adjusted based on the power-up timing of the module and the power-up and reset sequence timing of the chip. For ESP32's power-up and reset sequence timing diagram, please refer to Section *Power Scheme* in [ESP32 Datasheet](#).

8 Physical Dimensions

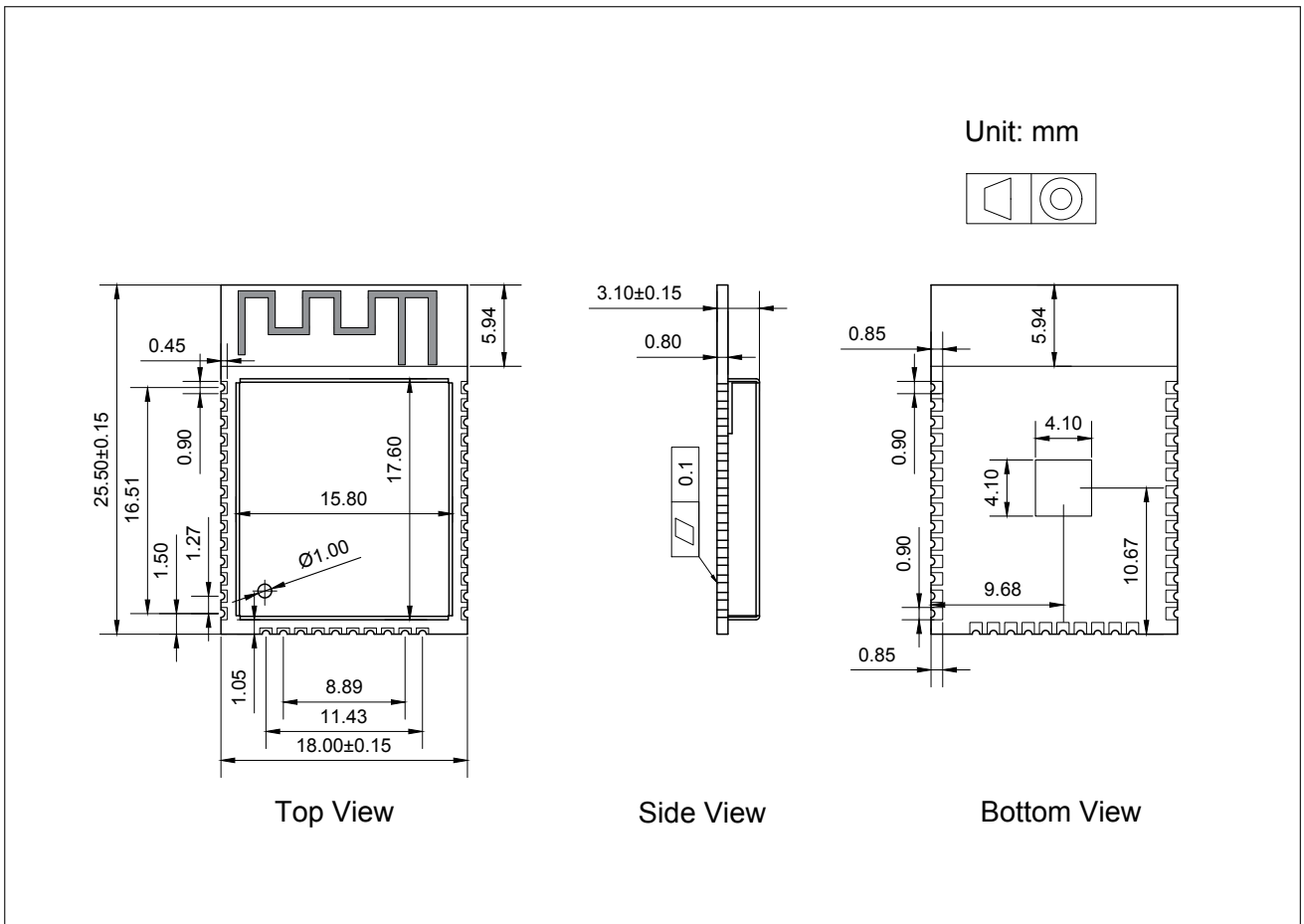

Figure 5: Physical Dimensions of ESP32-WROOM-32

Note:

For information about tape, reel, and product marking, please refer to [Espressif Module Package Information](#).

9 Recommended PCB Land Pattern

This section provides the following resources for your reference:

- Figures for recommended PCB land patterns with all the dimensions needed for PCB design. See Figure 6 [Recommended PCB Land Pattern](#).
- Source files of recommended PCB land patterns to measure dimensions not covered in Figure 6. You can view the source files for [ESP32-WROOM-32](#) with [Autodesk Viewer](#).

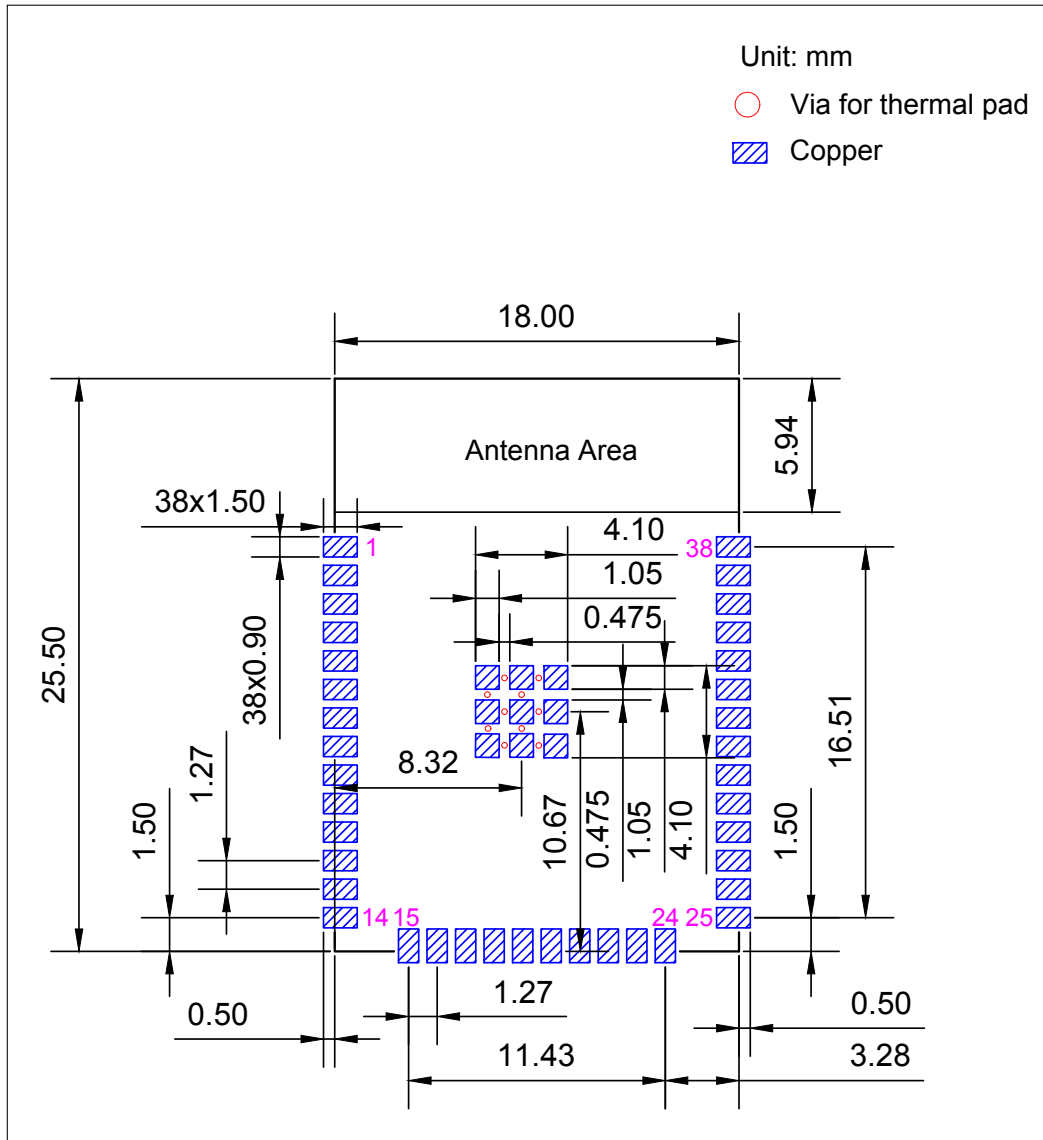

Figure 6: Recommended PCB Land Pattern

10 Product Handling

10.1 Storage Conditions

The products sealed in moisture barrier bags (MBB) should be stored in a non-condensing atmospheric environment of $< 40\text{ }^{\circ}\text{C}$ and 90%RH. The module is rated at the moisture sensitivity level (MSL) of 3.

After unpacking, the module must be soldered within 168 hours with the factory conditions $25 \pm 5\text{ }^{\circ}\text{C}$ and 60 %RH. If the above conditions are not met, the module needs to be baked.

10.2 Electrostatic Discharge (ESD)

- Human body model (HBM): $\pm 2000\text{ V}$
- Charged-device model (CDM): $\pm 500\text{ V}$

10.3 Reflow Profile

Solder the module in a single reflow.

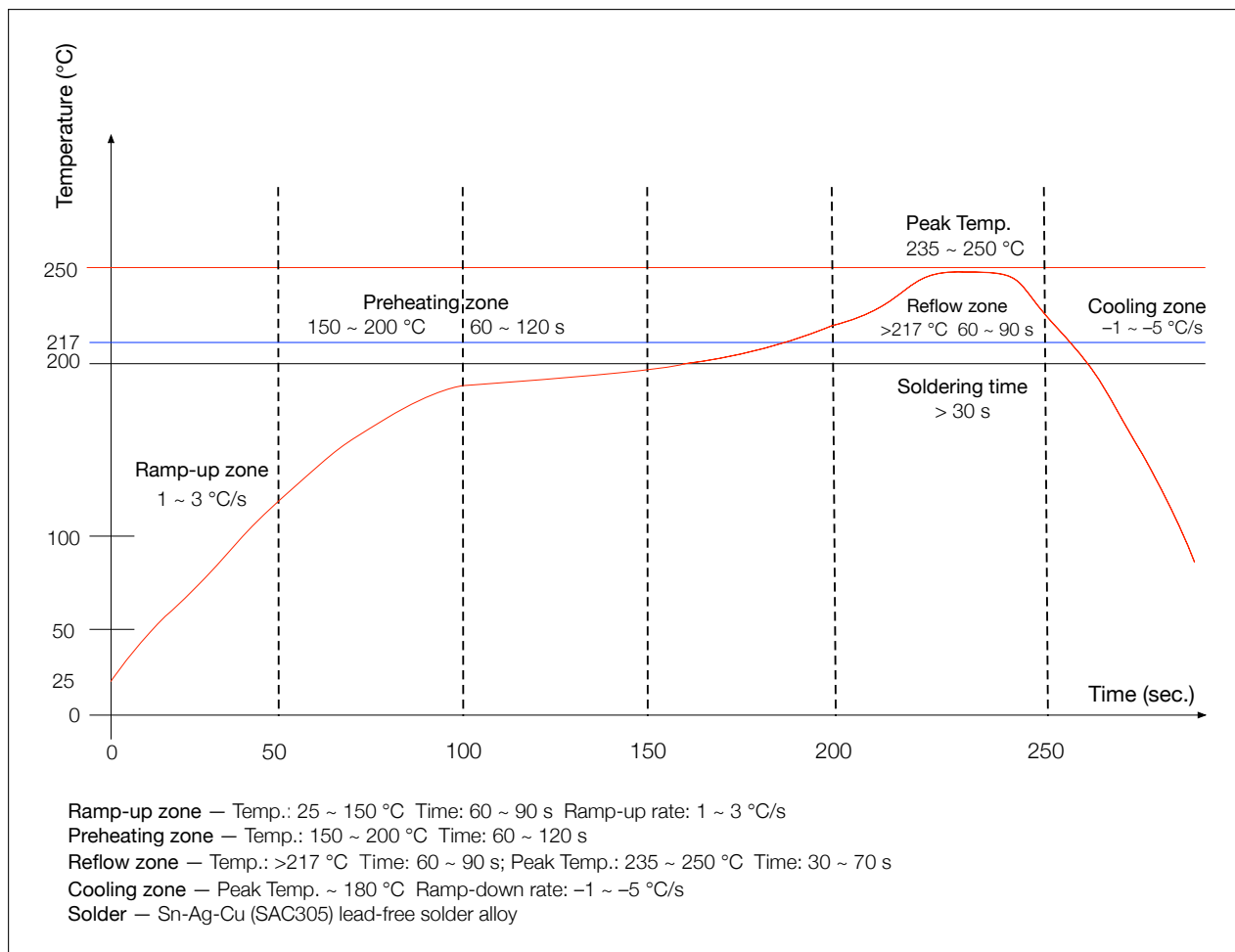

Figure 7: Reflow Profile

10.4 Ultrasonic Vibration

Avoid exposing Espressif modules to vibration from ultrasonic equipment, such as ultrasonic welders or ultrasonic cleaners. This vibration may induce resonance in the in-module crystal and lead to its malfunction or even failure. As a consequence, **the module may stop working or its performance may deteriorate.**

11 Related Documentation and Resources

Related Documentation

- [ESP32 Series Datasheet](#) – Specifications of the ESP32 hardware.
- [ESP32 Technical Reference Manual](#) – Detailed information on how to use the ESP32 memory and peripherals.
- [ESP32 Hardware Design Guidelines](#) – Guidelines on how to integrate the ESP32 into your hardware product.
- [ESP32 ECO and Workarounds for Bugs](#) – Correction of ESP32 design errors.
- *Certificates*
<https://espressif.com/en/support/documents/certificates>
- *ESP32 Product/Process Change Notifications (PCN)*
<https://espressif.com/en/support/documents/pcns>
- *ESP32 Advisories* – Information on security, bugs, compatibility, component reliability.
<https://espressif.com/en/support/documents/advisories>
- *Documentation Updates and Update Notification Subscription*
<https://espressif.com/en/support/download/documents>

Developer Zone

- [ESP-IDF Programming Guide for ESP32](#) – Extensive documentation for the ESP-IDF development framework.
- *ESP-IDF* and other development frameworks on GitHub.
<https://github.com/espressif>
- *ESP32 BBS Forum* – Engineer-to-Engineer (E2E) Community for Espressif products where you can post questions, share knowledge, explore ideas, and help solve problems with fellow engineers.
<https://esp32.com/>
- *The ESP Journal* – Best Practices, Articles, and Notes from Espressif folks.
<https://blog.espressif.com/>
- See the tabs *SDKs and Demos, Apps, Tools, AT Firmware*.
<https://espressif.com/en/support/download/sdks-demos>

Products

- *ESP32 Series SoCs* – Browse through all ESP32 SoCs.
<https://espressif.com/en/products/socs?id=ESP32>
- *ESP32 Series Modules* – Browse through all ESP32-based modules.
<https://espressif.com/en/products/modules?id=ESP32>
- *ESP32 Series DevKits* – Browse through all ESP32-based devkits.
<https://espressif.com/en/products/devkits?id=ESP32>
- *ESP Product Selector* – Find an Espressif hardware product suitable for your needs by comparing or applying filters.
<https://products.espressif.com/#/product-selector?language=en>

Contact Us

- See the tabs *Sales Questions, Technical Enquiries, Circuit Schematic & PCB Design Review, Get Samples* (Online stores), *Become Our Supplier, Comments & Suggestions*.
<https://espressif.com/en/contact-us/sales-questions>

Revision History

Date	Version	Release notes
2023-02-13	v3.4	<p>Major updates:</p> <ul style="list-style-type: none"> Removed contents about hall sensor according to PCN20221202 Added Section 10: <i>Product Handling</i> <p>Other updates:</p> <ul style="list-style-type: none"> Added strapping pin timing in Section 2.3: <i>Strapping Pins</i> Added source files of PCB land patterns and 3D models of the modules (if available) in Section 6: <i>Recommended PCB Land Pattern</i>
2022.03	v3.3	<p>Added a link to RF certificates in Table 1</p> <p>Updated Table 5</p> <p>Added a note below Figure 5</p> <p>Added Section 11: <i>Related Documentation and Resources</i></p>
2021.08	v3.2	<p>Replaced Espressif Product Ordering Information with ESP Product Selector</p> <p>Updated the description of TWAI in Table 1</p> <p>Labeled this document as (Not Recommended For New Designs)</p>
2021.02	V3.1	<p>Modified the note below Figure: Reflow Profile.</p> <p>Updated the trade mark from TWAI™ to TWAI®</p> <p>Deleted Reset Circuit and Discharge Circuit for VDD33 Rail in Section 7: <i>Peripheral Schematics</i></p> <p>Updated Figure 5: <i>Physical Dimensions of ESP32-WROOM-32</i> and Figure 6: <i>Recommended PCB Land Pattern</i></p>
2020.11	V3.0	<p>Added TWAI™ in Table 1;</p> <p>Added a note under Figure: Reflow Profile;</p> <p>Updated the C value in RC circuit from 0.1 μF to 1 μF;</p> <p>Provided feedback link.</p>
2019.09	V2.9	<ul style="list-style-type: none"> Changed the supply voltage range from 2.7 V ~ 3.6 V to 3.0 V ~ 3.6 V; Added Moisture sensitivity level (MSL) 3 in Table 1 <i>ESP32-WROOM-32 Specifications</i>; Added notes about "Operating frequency range" and "TX power" under Table 8 <i>Wi-Fi Radio Characteristics</i>; Updated Section 7 <i>Peripheral Schematics</i> and added a note about RC delay circuit under it; Updated Figure 6 <i>Recommended PCB Land Pattern</i>.
2019.01	V2.8	<p>Changed the RF power control range in Table 10 from -12 ~ +12 to -12 ~ +9 dBm.</p>
2018.10	V2.7	<p>Added "Cumulative IO output current" entry to Table 5: Absolute Maximum Ratings;</p> <p>Added more parameters to Table 7: DC Characteristics.</p>
2018.08	V2.6	<ul style="list-style-type: none"> Added reliability test items the module has passed in Table 1: <i>ESP32-WROOM-32 Specifications</i>, and removed software-specific information; Updated section 3.4: <i>RTC and Low-Power Management</i>; Changed the module's dimensions from (18±0.2) mm x (25.5 ±0.2) mm x (3.1±0.15) mm to (18.00±0.10) mm x (25.50±0.10) mm x (3.10±0.10) mm; Updated Figure 8: <i>Physical Dimensions</i>; Updated Table 8: <i>Wi-Fi Radio</i>.

Date	Version	Release notes
2018.06	V2.5	<ul style="list-style-type: none"> • Changed the module name to ESP32-WROOM-32; • Deleted Temperature Sensor in Table 1: ESP32-WROOM-32 Specifications; • Updated Chapter 3: Functional Description; • Added Chapter 6: Recommended PCB Land Pattern; Changes to electrical characteristics: <ul style="list-style-type: none"> • Updated Table 5: Absolute Maximum Ratings; • Added Table 6: Recommended Operating Conditions; • Added Table 7: DC Characteristics; • Updated the values of "Gain control step", "Adjacent channel transmit power" in Table 10: Transmitter Characteristics - BLE.
2018.03	V2.4	Updated Table 1 in Chapter 1.
2018.01	V2.3	Deleted information on LNA pre-amplifier; Updated section 3.4 RTC and Low-Power Management; Added reset circuit in Chapter 7 and a note to it.
2017.10	V2.2	Updated the description of the chip's system reset in Section 2.3 Strapping Pins; Deleted "Association sleep pattern" in Table "Power Consumption by Power Modes" and added notes to Active sleep and Modem-sleep; Updated the note to Figure 4 Peripheral Schematics; Added discharge circuit for VDD33 rail in Chapter 7 and a note to it.
2017.09	V2.1	Updated operating voltage/power supply range updated to 2.7 ~ 3.6V; Updated Chapter 7.
2017.08	V2.0	Changed the sensitivity of NZIF receiver to -97 dBm in Table 1; Updated the dimensions of the module; Updated Table "Power Consumption by Power Modes" Power Consumption by Power Modes, and added two notes to it; Updated Table 5, 8, 9, 10; Added Chapter 8; Added the link to certification download .
2017.06	V1.9	Added a note to Section 2.1 Pin Layout; Updated Section 3.3 Crystal Oscillators; Updated Figure 3 ESP-WROOM-32 Schematics; Added Documentation Change Notification.
2017.05	V1.8	Updated Figure 1 Top and Side View of ESP32-WROOM-32 (ESP-WROOM-32).
2017.04	V1.7	Added the module's dimensional tolerance; Changed the input impedance value of 50Ω in Table 8 Wi-Fi Radio Characteristics to output impedance value of 30+j10 Ω.
2017.04	V1.6	Added Figure: Reflow Profile.
2017.03	V1.5	Updated Section 2.2 Pin Description; Updated Section 3.2 External Flash and SRAM; Updated Section 4 Peripherals and Sensors Description.
2017.03	V1.4	Updated Chapter 1 Preface; Updated Chapter 2 Pin Definitions; Updated Chapter 3 Functional Description; Updated Table Recommended Operating Conditions;

Date	Version	Release notes
		Updated Table 8 Wi-Fi Radio Characteristics; Updated Section: Reflow Profile; Added Chapter Learning Resources.
2016.12	V1.3	Updated Section 2.1 Pin Layout.
2016.11	V1.2	Added Figure 7 Peripheral Schematics.
2016.11	V1.1	Updated Chapter 6 Schematics.
2016.08	V1.0	First release.



www.espressif.com

Disclaimer and Copyright Notice

Information in this document, including URL references, is subject to change without notice.

ALL THIRD PARTY'S INFORMATION IN THIS DOCUMENT IS PROVIDED AS IS WITH NO WARRANTIES TO ITS AUTHENTICITY AND ACCURACY.

NO WARRANTY IS PROVIDED TO THIS DOCUMENT FOR ITS MERCHANTABILITY, NON-INFRINGEMENT, FITNESS FOR ANY PARTICULAR PURPOSE, NOR DOES ANY WARRANTY OTHERWISE ARISING OUT OF ANY PROPOSAL, SPECIFICATION OR SAMPLE.

All liability, including liability for infringement of any proprietary rights, relating to use of information in this document is disclaimed. No licenses express or implied, by estoppel or otherwise, to any intellectual property rights are granted herein.

The Wi-Fi Alliance Member logo is a trademark of the Wi-Fi Alliance. The Bluetooth logo is a registered trademark of Bluetooth SIG.

All trade names, trademarks and registered trademarks mentioned in this document are property of their respective owners, and are hereby acknowledged.

Copyright © 2023 Espressif Systems (Shanghai) Co., Ltd. All rights reserved.

[Not Recommended For New Designs \(NRND\)](#)